

Nieuwe
bouwhandleiding

Postordner



Naam:		Groep / klas:	
Inhoud		Delen:	Gereedschap:
2 stuks triplex	420 x 35 x 6 mm	A	potlood, liniaal, lijm, priem, schaar,
1 stuk triplex	460 x 135 x 6 mm	B	houtlijm, toffelzaag, figuurzaag
1 stuk triplex	380 x 25 x 6 mm	C	schuurpapier, boormachine, plakband,
1 latje	410 x 55 x 10 mm	D	lijmtangen / lijmklemmen
3 ophangogen			houtvijlen, boortjes Ø 1,5 en 5 mm

De bouwhandleiding:1. Overzicht - explosie:

Dit bouw pakketje bevat 3 ontwerpvoorstellen. Kies je favoriete ontwerp uit of ontwerp zelf een vorm voor de delen (A).

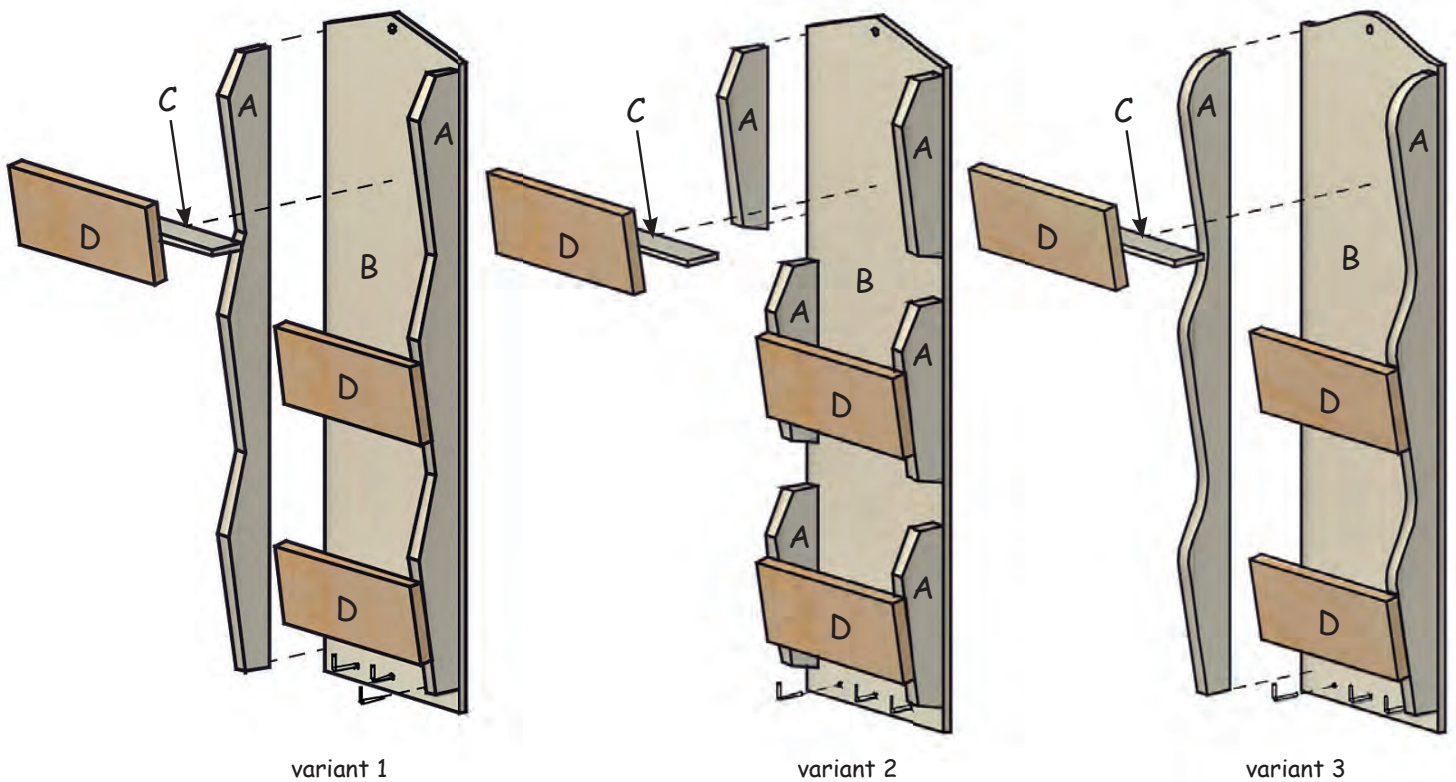

variant 1

variant 2

variant 3

2. De zijdelen (A):

- Knip de sjablonen voor deel (A) met een schaar uit.
- Plak de delen van de sjablonen voor de afzonderlijke varianten op de plaklijm aan elkaar.
- Plak de sjablonen met transparant plakband op het triplex.
- Zaag de delen (A) met een figuurzaag uit en werk de gezaagde randen met schuurpapier na.



variant 1



variant 2



variant 3

3. De achterwand - deel (B):

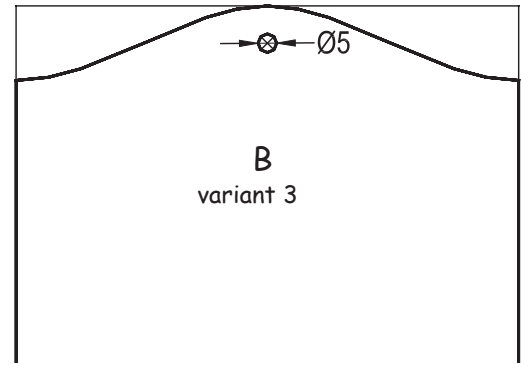
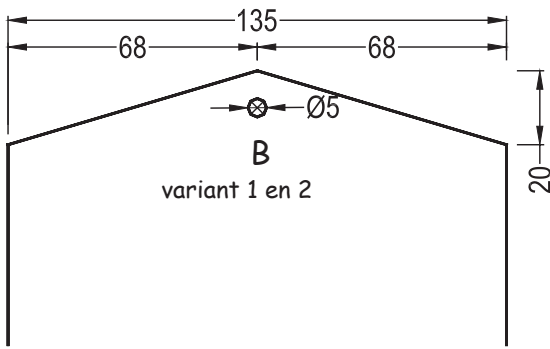

- Teken de schuine zijden en het gat $\text{Ø} 5$ mm op deel (B).
- Boor het gat en zaag de schuine zijden af.
- Werk de gezaagde randen met schuurpapier na.

- Knip de sjabloon uit en plak deze met transparant plakband op.
- Boor het gat $\text{Ø} 5$ mm en zaag de ronding met een figuurzaag uit.
- Werk de gezaagde randen met schuurpapier na.

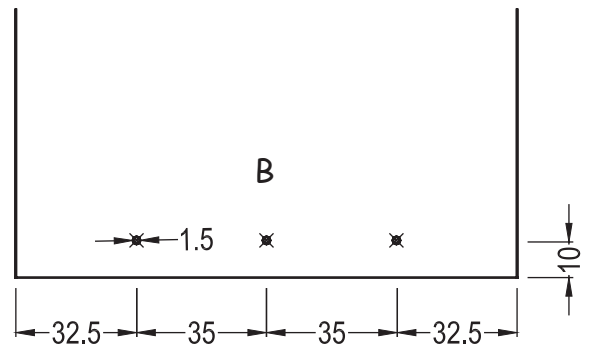
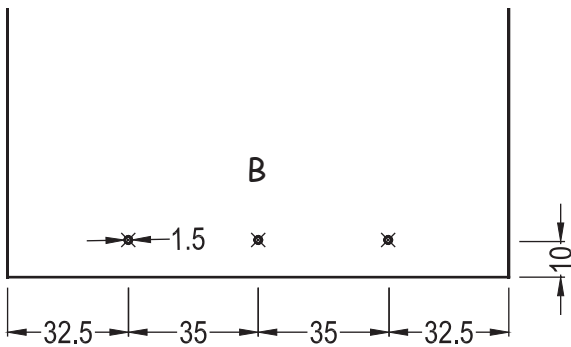

- Steek de prikpunten voor de ophangogen met een priem voor en boor de gaten $\text{Ø} 1,5$ mm.

4. De zijdelen (A) op de achterwand (B) lijmen:

- Lijm de delen (A) op de achterwand (B).

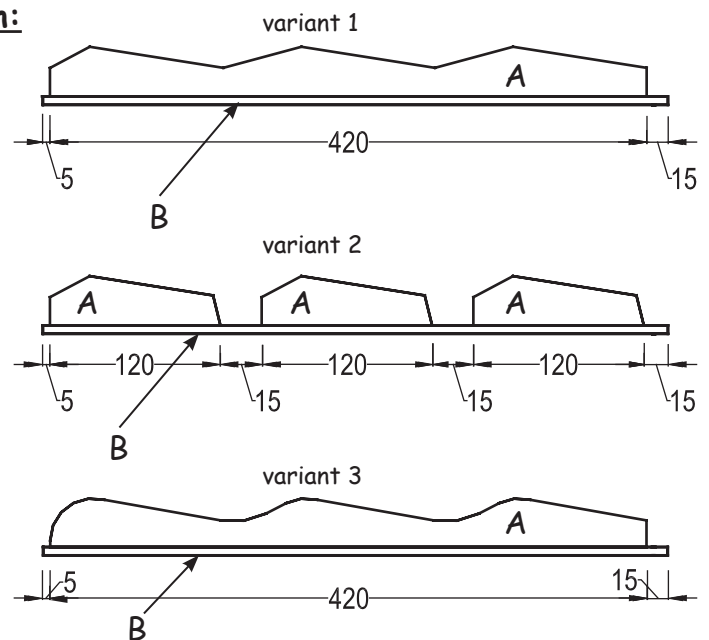
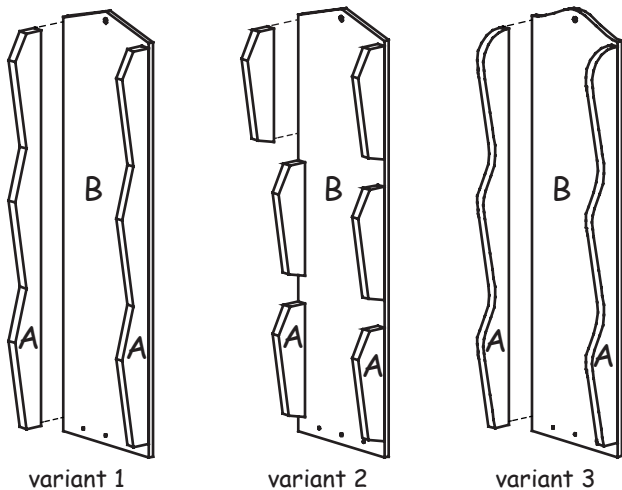

5. De delen (C):

• Zaag de delen (C) volgens de afbeelding af.

• Lijm de delen (C) zo tussen de delen (A), dat ze gelijk met de voorkant liggen.

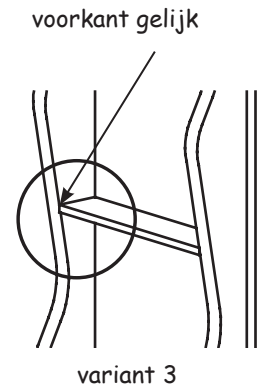
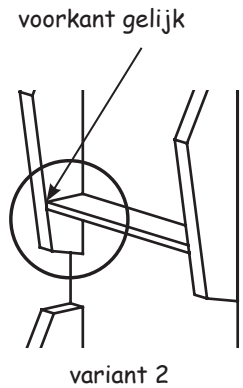
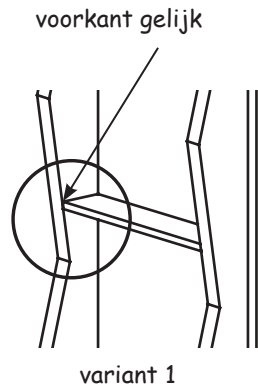
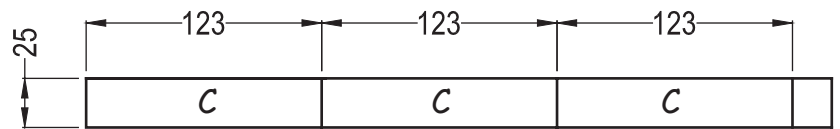
**6. De delen (D):**

• Zaag de delen (D) af.

• Lijm de delen (D) op de delen (A, C).

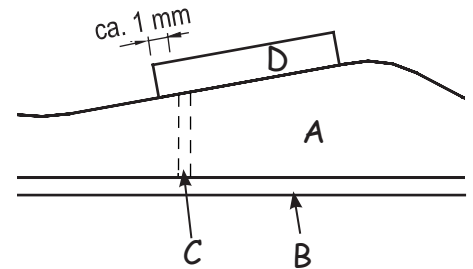
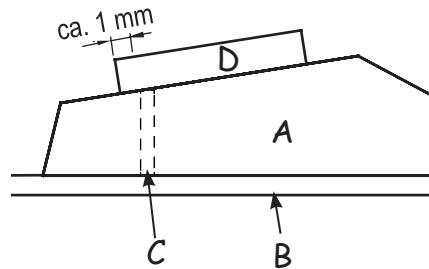
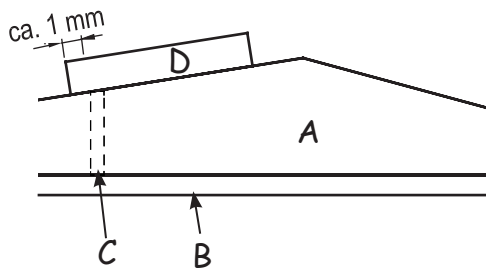
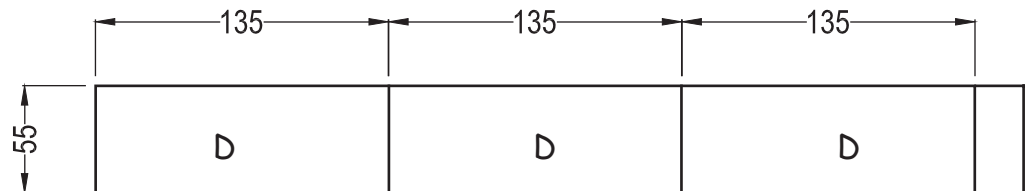
**7. De ophangogen:**

• Schroef de 3 haken in de gaten van deel (B).

8. Het oppervlak vormgeven:

Werk alle randen met schuurpapier na. Verf en versier het oppervlak van je werkstuk aan de hand van je eigen ideeën en voorstelling.

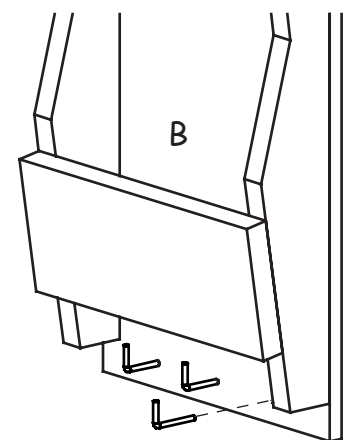

Veel plezier en succes!



Sjablone part B variant 3
M 1:1

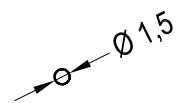
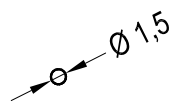
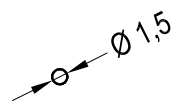

Sjablone aan elkaar lijmen
M 1:1



lijm oppervlak

Aduis.

variant 1

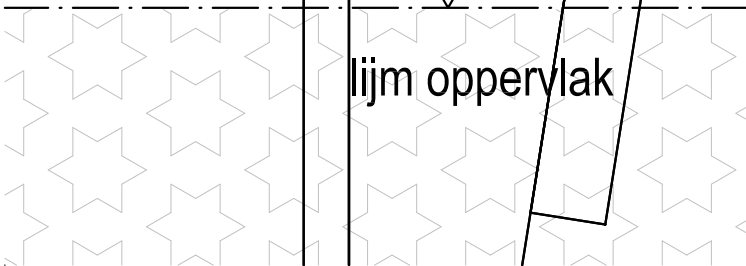

Sjablone aan elkaar lijmen
M 1:1



variant 2



lijm oppervlak

Aduis.

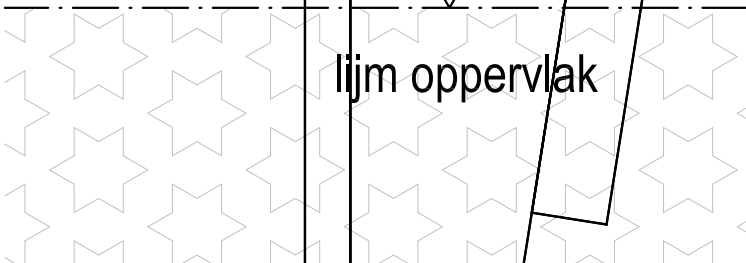

Sjablone aan elkaar lijmen
M 1:1



variant 3



lijm oppervlak

Aduis.

