

Kerstman

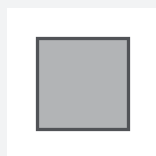

GEREEDSCHAP:



schuurpapier



houtlijm / alleslijm

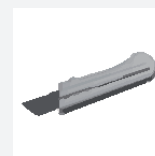

cutter

KLASSE:

INHOUD:

- 1 karton gestanst
- 1 Karton gestanst
- 3 golfkarton
- 1 lat
- 3 latten
- 2 latten
- 2 wiebelogen

OK✓

AFMETINGEN:

- A3 / 1,3 mm dik
- A4 / 1,3 mm dik
- 350 x 50 mm
- 195 x 10 x 10 mm
- 130 x 10 x 10 mm
- 35 x 10 x 10 mm
- Ø 14 mm

1 Overzicht:

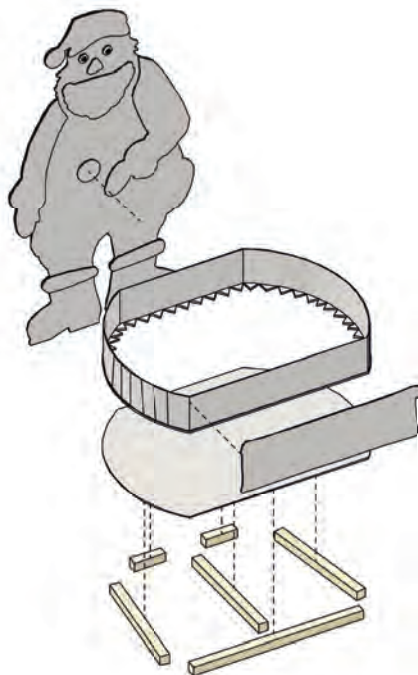

Verschaf jezelf een eerste overzicht.

OK/

2 Bodem in elkaar lijmen:

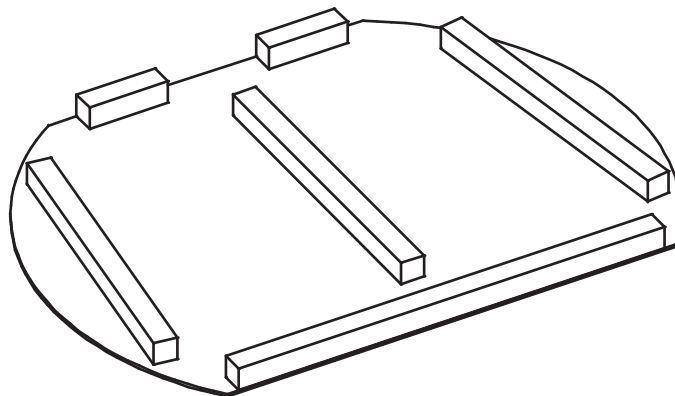

Verwijder voorzichtig alle **gestante delen** van het karton. Schuur daarna de randen met **fijn schuurpapier**. Lijm de latten op de kartonnen bodem zoals aangegeven op de illustratie.

OK/

3 Zet de onderdelen in elkaar:



Lijm de **armen, kwast, neus, baard, muts** en **wiebelogen** op de Kerstman. Lijm de kerstman en de zak op de bodem.

OK/

4 Afwerking:

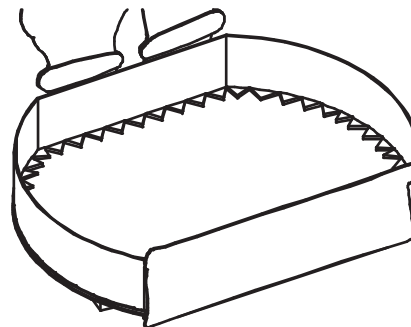
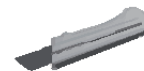
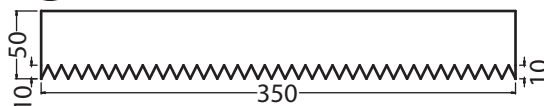

Snijd de **3 stroken golfkarton** zoals afgebeeld. Buig de **gekerfde kant** haaks om en druk de groeven aan de gekerfde kant glad. Vorm de stroken golfkarton tot de vorm van de bodem en lijm ze vast. Bevestig ze ook aan de Kerstman en de zak.

Maak van je Kerstman een echte blikvanger en schilder hem in de juiste kleuren!

Veel plezier en succes!

OK/