

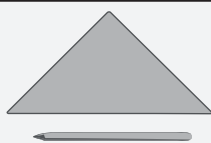

Bureauset



GEREEDSCHAPSVORSTEL:



potlood & lineaal

boortje
Ø 10 mm

figuurzaag



toffelzaag



schuurpapier



houtlijm

NAAM:

GROEP / KLAS:

INHOUD:

AFMETINGEN:

OMSCHRIJVING:

ONDERDELEN:

1 triplex plaat



232 x 122 x 4 mm

bodem (c.q. achterwand)

H

2 houten planken



232 x 80 x 10 mm

zijwanden

A, B

1 houten plank



102 x 30 x 10 mm

F

3 houten planken



102 x 80 x 10 mm

C, D, E

1 houten plank



102 x 40 x 10 mm

G

1 Overzicht:

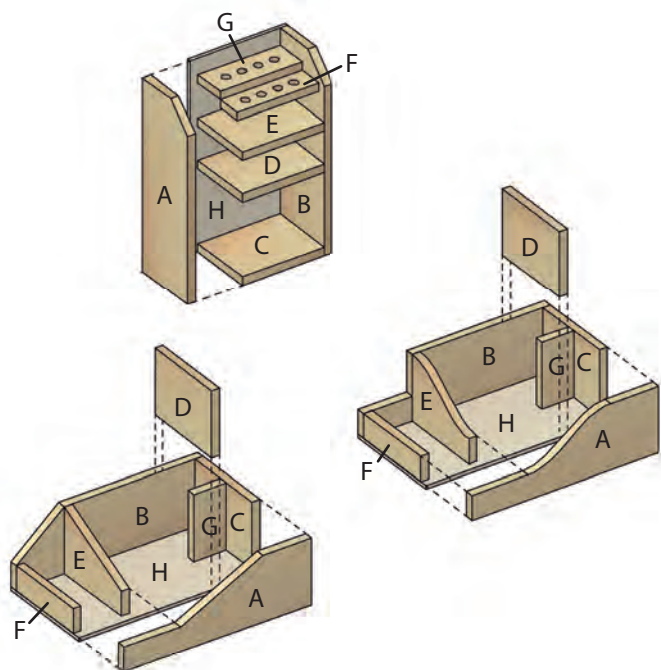

Verschaf jezelf een eerste overzicht.

OK✓

2 Variant 1:

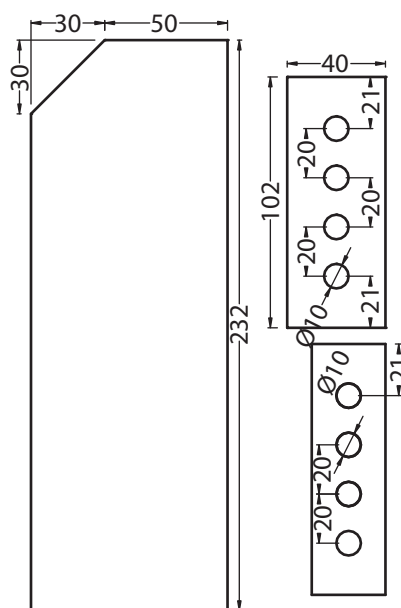

Breng de vormen van bestek 1 over op het hout. **Boor** eerst de **gaten Ø 10 mm** en **zaag** vervolgens de delen uit.

OK✓

3 Variant 2 of 3:

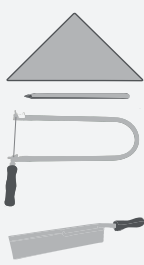
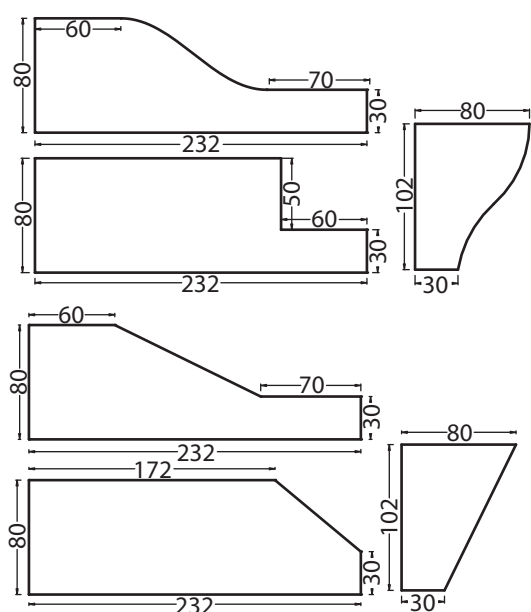

Breng voor **variant 2** de vormen van **bestek 1 & 2** of voor **variant 3** de vormen van **bestek 2 & 3** op het hout over en zaag de delen uit. Kort de **lat (G) (102 x 40 x 10 mm)** in tot **80 mm** voor de varianten 2 en 3.

OK✓

4 De afwerking:

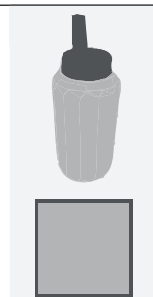
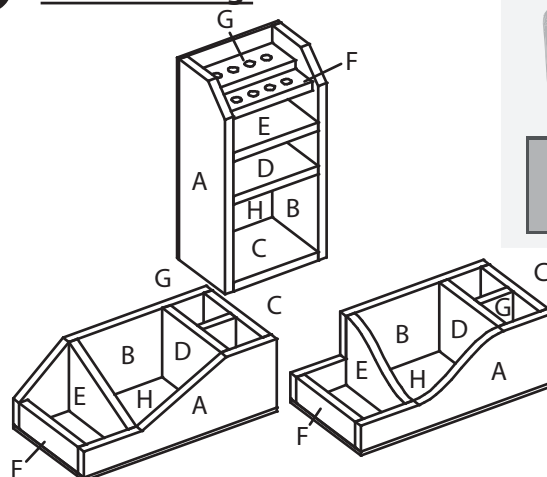

Lijm de framedelen volgens de afbeelding aan elkaar. Tot slot moet nog de **triplexplaat (H) (232 x 122 x 4 mm)** als **bodem (c.q. achterwand)** worden opgelijmd. Werk nu nog alle **randen met schuurpapier** na. Om het hout langdurig te beschermen, kun je het het best van een laag **blanke lak** voorzien.

Veel succes en plezier!

OK✓

Tekening 1

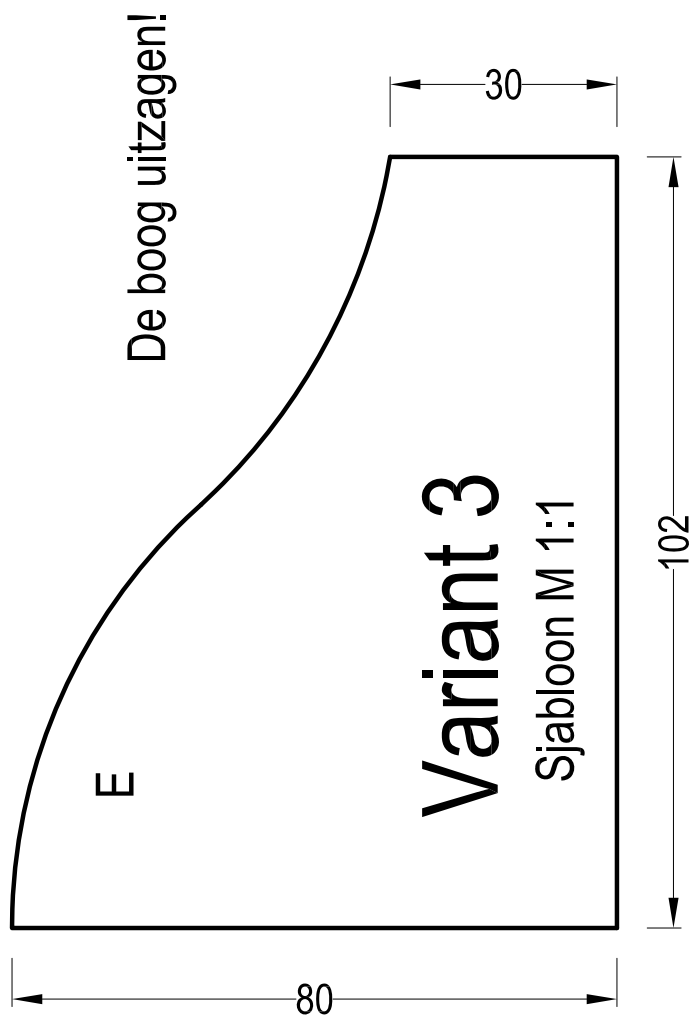
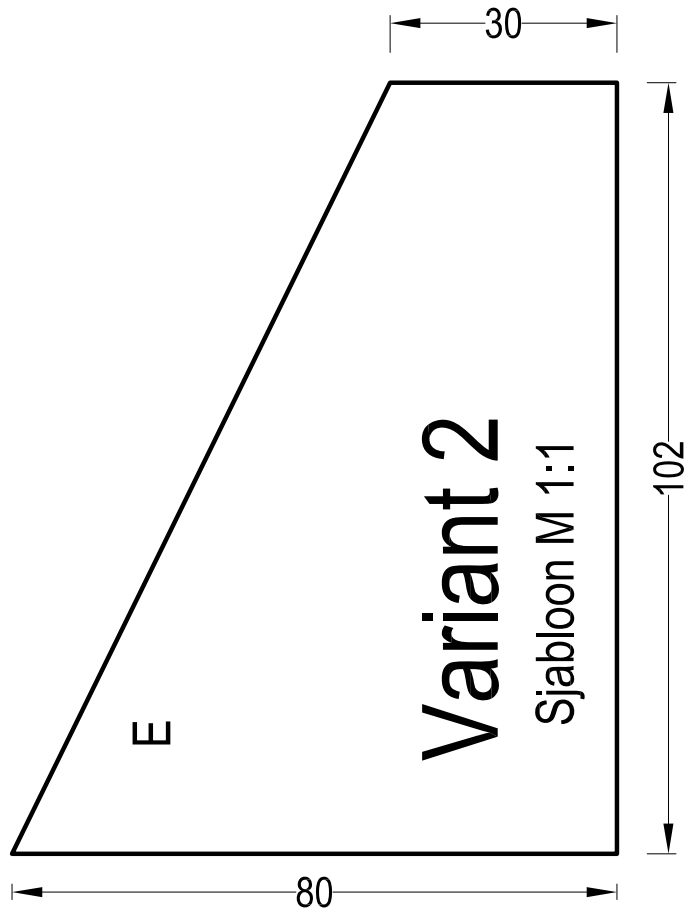
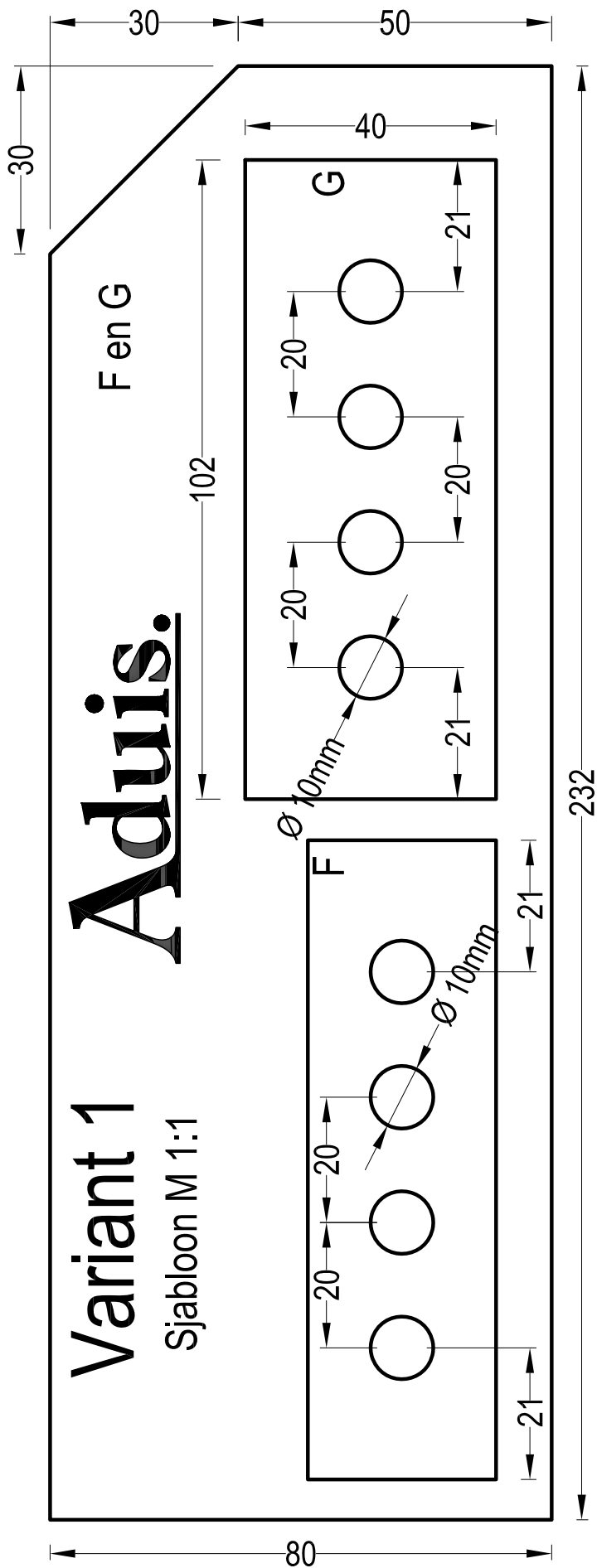

Tekening 2

Variant 2

Sjabloon M 1:1

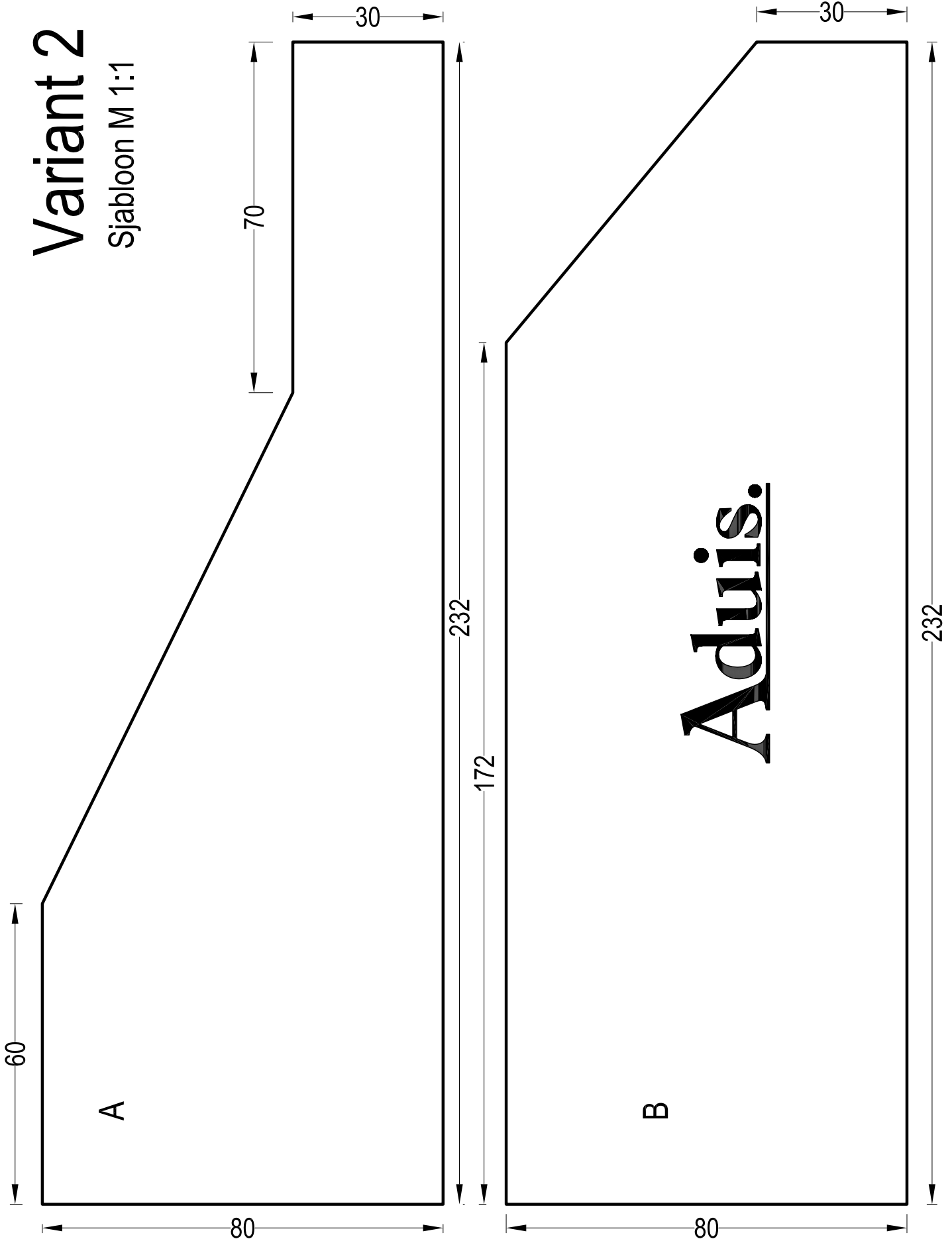

Tekening 3

Variant 3

Sjabloon M 1:1

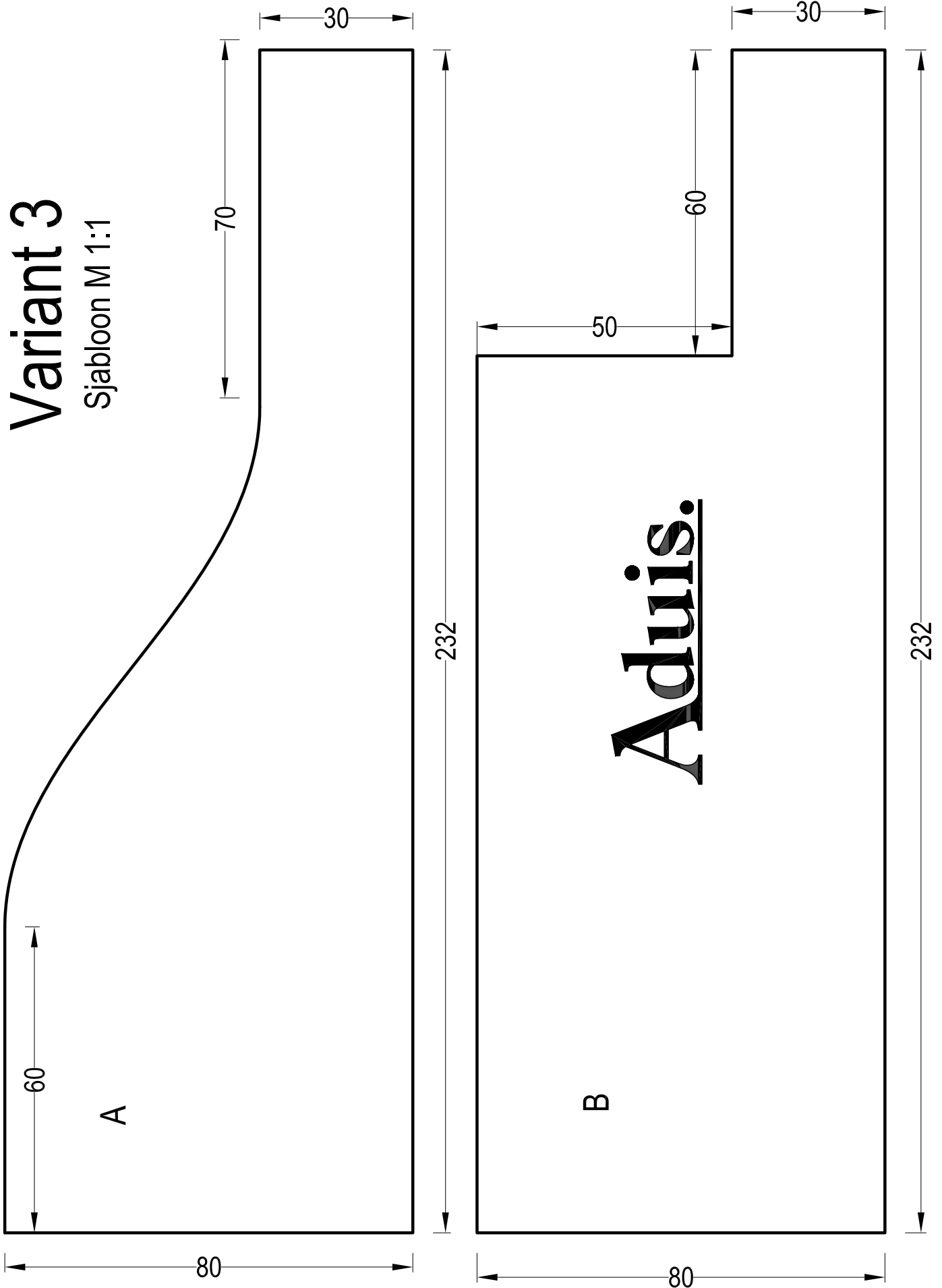

A

B

Aduis.