

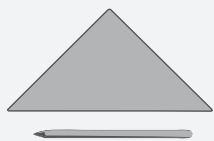

Sleutelbord „Familie“



GEREEDSCHAP:



potlood en liniaal



schaar



plakband

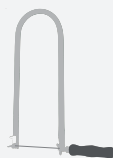

figuurzaag



schuurpapier



houtlijm / alleslijm

boortje
Ø 3 mm

NAAM:

KLAS/GROEP:

INHOUD:

AFMETINGEN:

ONDERDELEN:

1 stuk triplex

OK✓

200 x 115 x 4 mm

A

1 grenenhouten lat

200 x 50 x 10 mm

B

1 katoenen koord

880 mm

E

4 houten ballen

Ø 25 mm, gat 6 mm

C

4 houten kralen

Ø 8 mm, gat 2 mm

D

1 Overzicht:

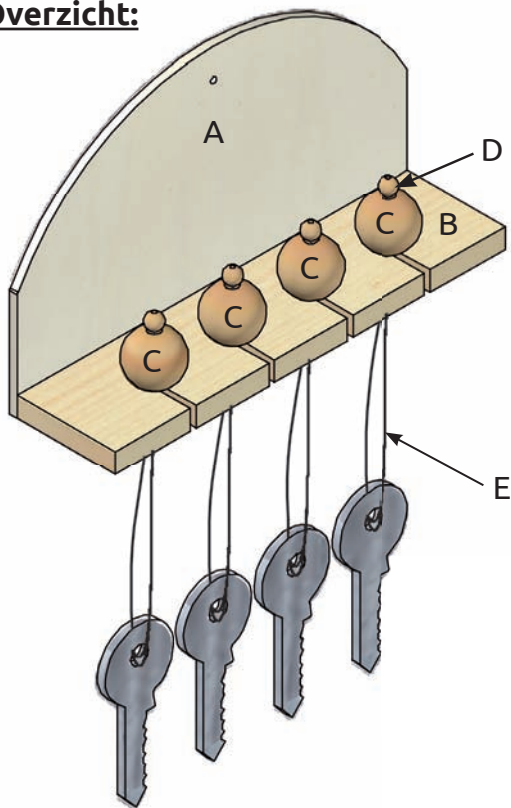

Verschaf jezelf een eerste **overzicht**.



2 Deel (A):

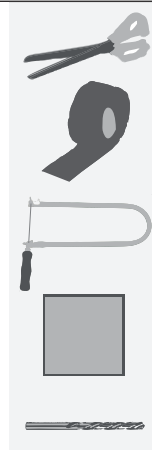
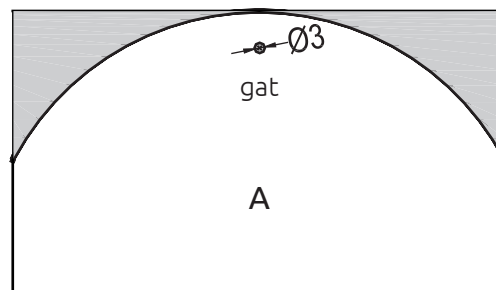

Knip het **sjabloon** van deel (A) grof met de schaar uit en plak deze met transparant plakband op het triplex.

Boor het gat **Ø 3 mm**.

Zaag deel (A) met de **figuurzaag** uit.

Werk de randen en vlakken met schuurpapier na.



3 Deel (B):

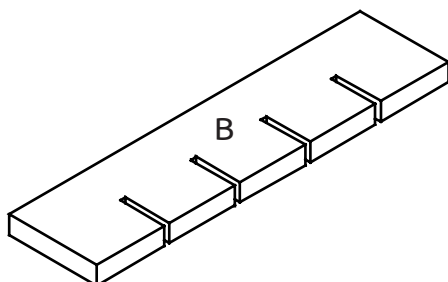
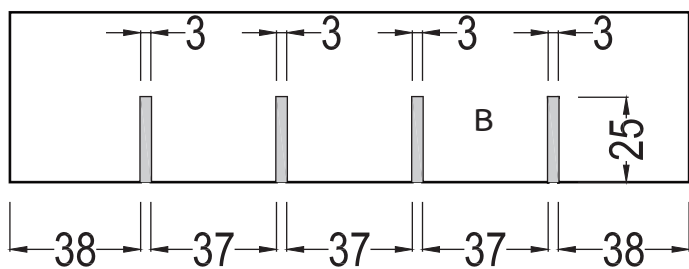
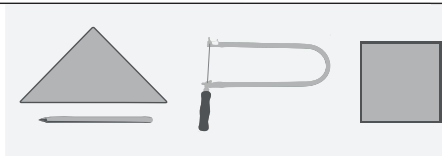

Breng de **afmetingen** zoals weergegeven op de afbeelding over op de grenen lat (B).

Zaag de **inkepingen** met de figuurzaag uit.

Werk deel (B) met **schuurpapier** na.



4 In elkaar zetten deel (A, B):

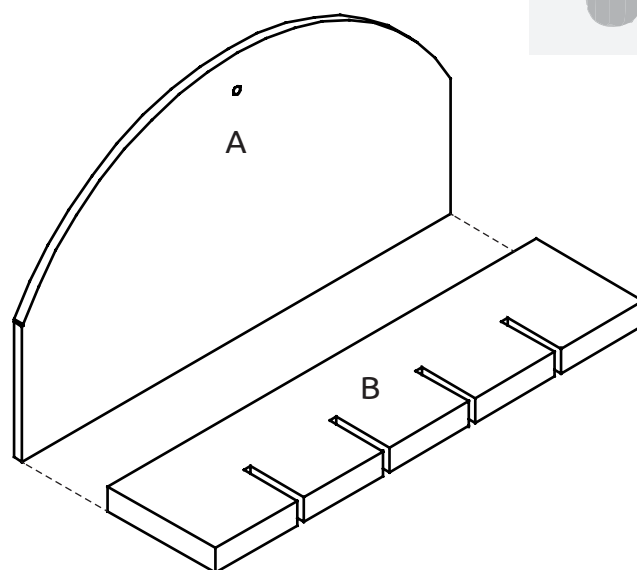

Lijm lat (B) op het triplex (A).



5 Voltooien en versieren:



Knip 4 stukken van het **katoenen koord** met een lengte van ca. 200 mm.

Rijg de houten bal (C), de houten kraal (D) en een sleutel volgens de afbeelding op het katoenen koord (E) en leg een knoop boven de houten kraal (D).

Versier en verf je sleutelbord volgens je eigen ideeën.

VEEL PLEZIER EN SUCCES!



OK✓

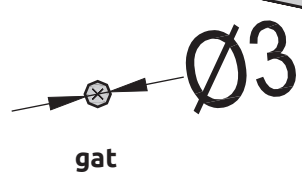

A

sjabloon
M=1:1